

Varenummer: 204380M24100D1V

Beskrivelse: E+G Justerfod
GN 43-80-M24-100-D1-V

Note: V Uden møtrik, udvendig sekskant i toppen, spændeflade i bunden

Mål

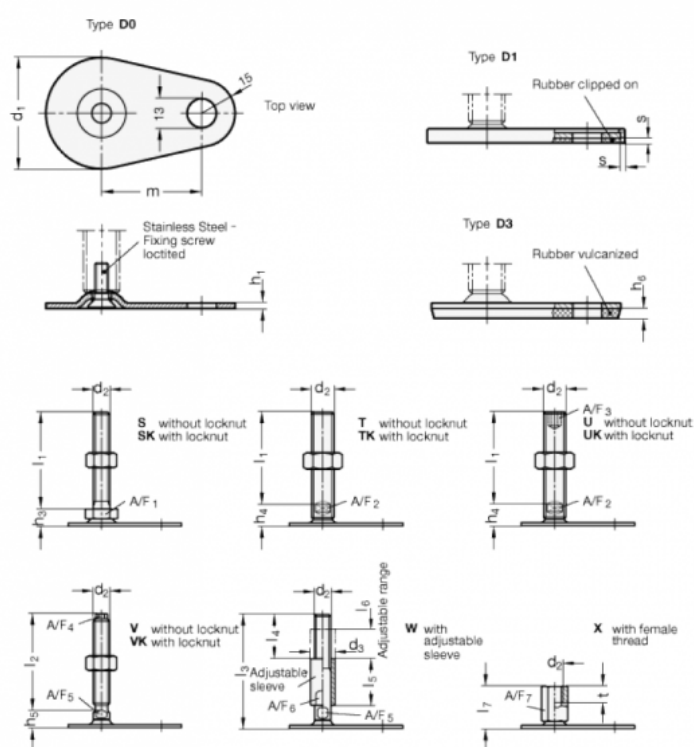

A/F4 = 17	m = 70
A/F5 = 20	s = 2
d1 = 80	
d2 = M24	
h1 = 3	
h5 = 15	
h6 =	
l2 = 100	